

NEW GENERATION **GHS-A SERIES AIR FILTERS** **MAKE AIR PURE AGAIN**



MAKE AIR PURE AGAIN



Problems Brought by Polluted Compressed Air

Air is compressible; the air compressor does mechanical work to make itself smaller in size, air pressure increase after called compressed air.

Compressed air is an important driving force that is widely used in various industrial fields. All compressed air systems air comes from the atmosphere and the air contains a lot of dust, water vapor and unburned hydrocarbons and bacteria. In addition, the air compressor lubrication system will produce such contaminants. This oil is acidic, inferior and which doesn't have any lubrication, Pipeline corrosion from compressed air distribution system also pollutes the air.

When air is compressed, the contained vapor (including oil vapor and water vapor) and dust concentration will raise sharply, oil, steam concentrate into large globules, mixed

Typically there are different contamination from the below sources, such as atmospheric dirt, water vapor, oil vapor, micro-organism.



• Solid particles



• Pipe scale



• Liquid water



• Liquid oil



Oil vapor

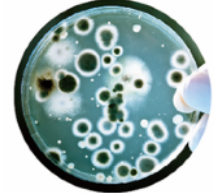

• Micro-organisms

If there is no air treatment equipment installed, the above mentioned acidic abrasive sludge will enter your compressed air system, pipeline corrosion, damage pneumatic components and equipment, and to influence the final product quality.

Advanced Filtration Technology for Contaminations

The compression process introduces lubricant and wear particles into the system, piping distribution and storage tanks foster contaminants in the form of rust, pipe scale and bacteria. PF, AO, AA,AX,ACS, AR and AAR filters efficiently remove these contaminants to provide the best air purity and protect downstream equipment and your processes, saving costs.

• PF

Coarse Pre-Filtration

As a primary filter, particles whose diameter down to 5 μm can be removed, the max. residual oil content is negligible. Changed every 6000 hours.

• AO

High Efficiency General Purpose

High efficiency general protection, dust particles, water mist & oil mist whose diameter down to 1 μm can be removed, the residual content of oil mist does not exceed 0.6 mg/m^3 (21°C), 1ppm(w), changed every 8000 hours.

• AA

High Efficiency Oil Removal Filtration

Dust particles, water mist and oil mist down to 0.01 μm can be removed, the residual content of oil mist does not exceed 0.01 mg/m^3 (21°C), 0.01ppm(w), changed every 8000 hours.

• AX

Ultra High Efficiency Filtration

Ultra-efficient filtration, solid particles, liquids, oil aerosols, odors, and vapors are effectively removed at a high efficiency of 99.99% as small as 0.01 micron, the residual content of oil mist does not exceed 0.001 mg/m^3 (21°C), 0.001ppm(w), changed every 8000 hours.

• AR

General Purpose Dust Filtration

Dry particle removal down to 1 μm , installed after adsorption air dryer, change every 6000 hours.



• ACS

Oil Vapour Reduction

Activated carbon filter element made from thousands of activated carbon granules of sufficient thickness, oil vapor & odor can be removed, the max. resident content of oil vapor does not exceed 0.003 mg/m^3 (21°C), 0.003 ppm(w), changed when oil vapor detected.

• AAR

High Efficiency Dust Filtration

Dry particles removal down to 0.01 μm can be removed, installed after adsorption air dryer, change every 6000 hours.

Product Selection

Below flow rates of compressed air are calculated in rated working pressure of 7 bar (100 psi g) with reference to 20 °C.

Model	Inlet/Outlet (Rc)	Rated Air Flow at 7 bar			Dimensions (mm)					
		L/S	Nm3/min	Nm3/h	Scfm	Width (W)	Depth (D)	Height (H)	A	B
GHS-A0017	1/2"	16.7	1	60	35.3	90	82	275	39.2	176.9
GHS-A0025	3/4"	25.0	1.5	90	53.0	90	82	275	39.2	176.9
GHS-A0030	1/2"	30.0	1.8	108	63.6	90	82	310	39.2	211.9
GHS-A0035	3/4"	33.3	2	120	70.6	90	82	310	39.2	211.9
GHS-A0058	3/4"	46.7	2.8	168	98.6	120	113	425	55	269.5
GHS-A0068	1"	60.0	3.6	216	127.1	120	113	425	55	269.5
GHS-A0080	1"	80.0	4.8	288	169.5	120	113	525	55	369
GHS-A0145	1-1/2"	120.0	7.2	432	254.3	120	113	525	55	369
GHS-A0220	2"	200.0	12.0	720	423.6	160	151	746	72.5	468
GHS-A0260	2-1/2"	233	14.0	840	494.4	160	151	746	72.5	468
GHS-A0330	2"	267.2	16.0	960.0	564.8	160	151	1026	72.5	748
GHS-A0360	2-1/2"	350.0	21.0	1260.0	741.5	160	151	1026	72.5	748
GHS-A0430	3"	500.0	30.0	1800.0	1059.3	200	186	782	81.5	561.5
GHS-A0620	3"	620.0	37.2	2232.0	1313.6	200	186	1049	81.5	782.5

The max. working pressure: 16 bar, the max. working temperature: 80 °C

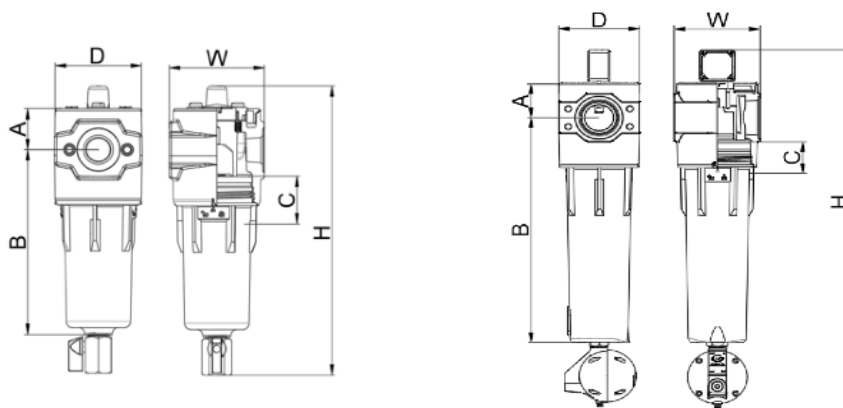

• GHS-A017 to GHS-A0145

• GHS-A0220 to GHS-A0620

Pressure	Barg	1	2	3	4	5	6	7	8	9	10	11	12	13	14	15	16
	Psig	15	29	44	59	73	87	100	116	131	145	160	174	189	203	219	232
Pressure Correction Factor		0.38	0.53	0.65	0.76	0.85	0.93	1.00	1.07	1.13	1.19	1.23	1.31	1.36	1.41	1.46	1.51

To correctly select an air filter model, the flow rate of the air filter must be adjusted for the minimum operating (inlet) pressure at the point of installation.

Calculate the adjust filtration capacity:

1. Minimum Filtration Capacity = Compressed Air Flow Rate x pressure correction factor rate.
2. Using the minimum filtration capacity, select an air filter model from the flow rate tables above (air filter selected must have a flow rate equal to or greater than the minimum filtration capacity).

Accessories Designed for Air Filters



Differential pressure indicator/gauge

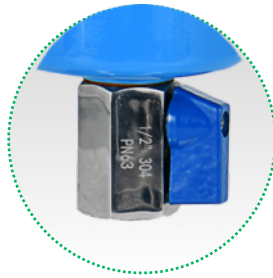

External Float drain HAD10B



External Float drain HAD10B



External float drain HAD20B

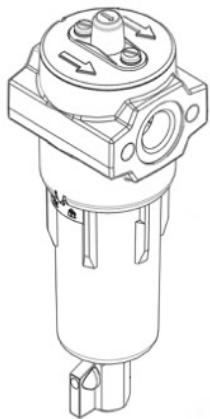

Standard Configuration
GHS-A0017 to GHS-A0145

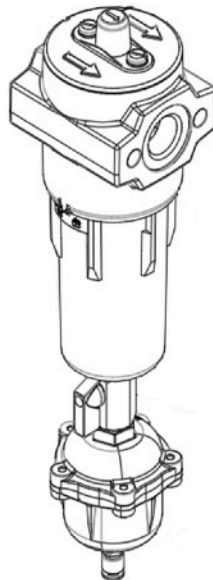

Optional

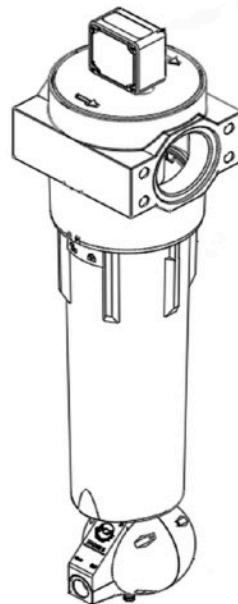

Standard Configuration
GHS-A0220 to GHS-A0620

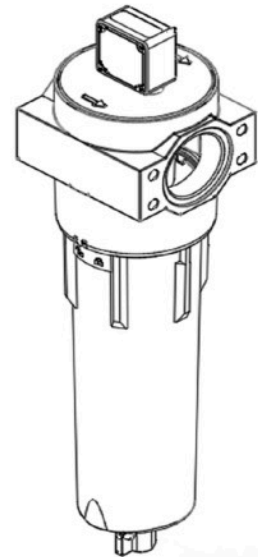

Optional

OEM Capabilities

When you need a special filter for a unique application, Yun Air experts are ready to work with you. We can tailor a configuration to meet your special need from the wide variety of filter media available. In addition, with LEAN manufacturing, we can produce specials in reasonable quantities, in a reasonable amount of time, at a reasonable price. Not only will this enhance the performance of your product, but it will benefit you with aftermarket sales of replacement elements.

OUR RANGES OF PRODUCTS INCLUDE THE FOLLOWING:

- Compressed air dryers
- Compressed air filters
- Compressed air water separators
- Alternative air filter elements
- Condensate auto drain
- Compressed air accessories
- Portable mask

We reserve the right to make technical changes. Error excepted.



Yun Air Technology Co., Ltd.



Hongrijia Depurate Facility Science & Technology Co.,Ltd

Building E1-1-1, 1-2 floors, Qun Yi
Leng Manufacturing Industrial Park,
Tong Hu Town, Hui Cheng District,
Huizhou, Guangdong, China



Office Address:

Rui ji 1st Rd, Longgang District
Shenzhen, Guangdong, China



+86 150 1366 4809



info@yun-air.com



www.yun-air.com

